



Installation and Operation Manual for Perenio® UV Lamp

(Model: PELUV01, PEKUV01)

April, 2023

Introduction

The UV Lamp is a low-pressure mercury lamp designed to kill germs and dust mites with ultraviolet radiation at the site of installation.

The present Manual contains a detailed description of the device, as well as instructions for its installation and operation.

Copyrights

Copyright of ©Perenio IoT spol s r.o. All rights reserved.

The **Perenio[®] Smart Health** trademark is owned by *Perenio IoT spol s r.o.* (hereinafter referred to as the *Perenio IoT*). All other similar trademarks and names, as well as logos and other symbols are the property of their respective owners*.

All materials under **Perenio[®] Smart Health** tradename contained therein are protected in accordance with international and local laws including Acts on Copyrights and related rights.

Any reproduction, copying, publication, as well as further distribution or public display of material contained in the present document (whether in full or in part) shall not be allowed until an appropriate permission of the copyright owner is obtained.

Any unauthorized usage of materials contained herein may lead to civil liability and criminal prosecution in accordance with applicable laws.

Any eventual mentioning of other company names and equipment in the present document is made solely for the purpose of clarifying and describing the device operation and shall not infringe on the third party's intellectual property rights.

***iOS** is the registered trademark of *CISCO TECHNOLOGY, INC.*; **Android** is the registered trademark of *Google Inc.*; **Google Play** and **Google Home** are trademarks of *Google Inc.*; **App Store**, **Apple Siri** are registered trademarks of *Apple Inc.*; **Linux** is the registered trademark of *Linus Torvald*; **Amazon Alexa** is the registered trademark of *Amazon Technologies, Inc.*

Responsibility and Technical Support

The present document is prepared in accordance with all necessary requirements and contains detailed information on the device installation, configuration and control valid as of the date of its issue.

Perenio IoT reserves the right to modify the device and make corrections or changes to this document without prior notice of the User, and shall not be responsible for any potential negative consequences which may arise from the use of an outdated version of the document, as well as for any possible technical and/or typographical errors, either omitted or accidental, or any related damage that may result from the document transfer or the use of the devices.

Perenio IoT shall make no guarantee with respect to any data contained herein including but not limited to the device merchantability and fitness for a particular purpose.

In case of any discrepancies between language versions of this document, the Russian version of this User Manual shall prevail.

For any technical issues, please contact your local *Perenio IoT* representative or the Tech Support Department at **perenio.com**.

The most common problems may be found in Section 8 of the present document and at **perenio.com** where you can also download the latest version of this Installation and Operation Manual.

Manufacturer:

Perenio IoT spol s r.o.

Na Dlouhem 79, Ricany – Jazlovice 251 01, Czech Republic

perenio.com

Conformance to Standards

CE

The device is CE certified and complies with the 2014/30/EU Electromagnetic Compatibility Directive of the European Union

UK

The device complies with the UKCA marking requirements for selling the device in the UK

CA

The device has passed all procedures of assessments established in Technical Regulations of the Customs Union and conforms with standards of the Customs Union

EAC

RoHS

The device complies with the requirements of Restriction of the Use of Certain Hazardous Substances (RoHS) in Electronic and Electrical Equipment (2011/65/EU Directive)



The crossed-out trash can symbol is used to label electrical and electronic equipment, and indicates its separate collection.

The symbol is given in accordance with the Directive 2012/19/EU on Waste Electrical and Electronic Equipment (WEEE)* and indicates that this equipment requires separate collection at the end of its life and must be disposed of separately from unsorted household waste.

To protect the environment and human health, please dispose of used electrical and electronic equipment according to approved safe disposal guidelines

| | | | | |
|----|----|----|----|----|
| | | | | |
| BG | CZ | DE | ES | FR |
| GR | IT | KZ | LT | LV |
| NL | NO | PL | RO | RU |
| SE | SK | TR | UA | UK |

Information about certificates received is indicated in section 7 of this document. Copies of certificated and declarations can be found in the appropriate section on the website **perenio.com**

Warnings and Restrictions

Prior to installation and operation of the device, the User shall carefully read and understand information contained herein.

ATTENTION! The warnings, precautions, and instructions contained in this document may not contain every possible hazardous situation. Use common sense when using the device.

Safety Operation Rules

1. The device shall be used as described in this manual only. Any other use not specified therein may cause fire and other hazards, as well as injury to persons.
2. Ventilate the room for at least **30 minutes** after the UV lamp stops working.
3. The most effective way to use the device is in rooms with no air circulation at an ambient temperature of +25°C.
4. The device must be installed a minimum of 1.8m away from plastic and rubber materials such as flexible duct, wire insulation, filters, etc., because the UVC light may damage them. Otherwise, such materials must be protected from direct UVC light using aluminum foil tape.
5. It is forbidden to operate the device, if any part of the device is damaged or cracked.
6. The device shall not be installed outdoors, or near water including humidifiers.
7. The device shall be kept away from direct sunlight, moisture and vibration.
8. It is not allowed to drop or throw the device, as well as attempt to repair it on one's own.
9. It is not allowed to use the device with a damaged power cord, or put the power cord near radiators, stoves or heaters.
10. It is not allowed to use detergents to clean any part of the device.
11. Prior to powering on the device, the UV tube shall be cleaned with a cotton cloth to remove dirt and fingerprints, otherwise it may shorten the UV tube lifespan.
12. It is recommended to replace the UV tube once a year notwithstanding its good condition.
13. If the UV tube is broken, all particles shall be swept into a plastic bag, sealed and disposed of properly, as well as the room must be well-ventilated, because the device contains mercury. Do not use a vacuum cleaner to pick up the waste and glass particles. Contact your local waste collection agency for proper disposal procedures.
14. Keep children away from the device, because it may emit a light attractive to them. Serious injury and electrocution might be possible. This device is intended to be operated by adults only.

Warnings and Precautions

- 1. The UV Lamp is not a medical device.**
2. People, pets and plants must not be present in the room under UVC and/or ozone exposure.
- 3. It is forbidden to look at the working UV tube, as any exposure to ultraviolet radiation will cause serious damage to the eyes and may lead to skin damage. Therefore, when the device is turned on, wear appropriate eye and skin protection from UV rays.**
4. Ingestion or contact with mercury or its vapor is hazardous to health. Avoid contact with mercury, if the device is damaged.
5. It is forbidden to touch the UV tube with wet hands.
6. The device is not intended to be used for removal of active mold growth. The UVC light exposure to existing mold growth can cause respiratory irritation and allergic symptoms.
7. The UVC light exposure may also cause fabric and painting discoloration.
8. The UVC light of the device does not provide a tanning effect, while its exposure to uncovered skin areas for more than 2-3 minutes will cause burns.
9. To prevent exposure to UV rays, the User must disconnect the device from the power source immediately after the disinfection process is finished.
10. Please read carefully all instructions and precautions in the QSG and this Operation Manual. Failure to follow the manufacturer's instructions may result in fire, electric shock, and other hazardous situations including human injury.
11. Do not use a UV lamp to sterilize medical instruments.

Warnings related to Ozone and UV

The germicidal effect of the **Perenio[®] PELUV01 UV Lamp** is provided by the use of UVC wavelengths of 260nm to 275nm.

The above wavelengths are peak to achieve the bactericidal effect of destroying cells of pathogenic organisms. Also, the operation of the lamp leads ozone generation in the air, which is effective in destroying microorganisms and removing odors. This type of disinfection does not harm the environment and does not require special maintenance and storage conditions.

However, ozone in itself is highly toxic and can have adverse effects on human health, such as:

- Chest pains, cough, shortness of breath, and throat irritation;
- Chronic respiratory diseases such as asthma;
- Decreased ability of the body to fight respiratory infections;
- Inflammation and damage to the mucous membrane of the lungs.

Exposure to ultraviolet radiation can cause the following adverse effects:

- Skin and eye burns;
- Various mutations (skin cancer, skin melanoma, premature aging).

Therefore, extreme care and precautions must be taken when using **PELUV01 UV Lamp**. All instructions from this document must be followed.

ATTENTION! All Products and the Mobile Application of the Company (including any future software and hardware whether in-house or third-party developed) are not intended for emergency responses and cannot be used as fire-extinguishing equipment and/or for emergency intervention, including but not limited to fires, flooding, gas leaks or explosions, burglary and theft, as well as natural disasters and other force majeure circumstances leading to damage and/or losses incurred by the Client or caused to their estates, personal property and/or other products, devices, personal data and privacy.

Table of Contents

| | |
|---|----|
| Introduction | 3 |
| Copyrights..... | 3 |
| Responsibility and Technical Support..... | 4 |
| Conformance to Standards | 5 |
| Warnings and Restrictions | 6 |
| Table of Contents | 9 |
| 1 General Description and Specifications..... | 11 |
| 1.1 Device Purpose | 11 |
| Buttons, Ports and Indicators..... | 12 |
| 1.2 Technical Specification | 13 |
| 1.3 Scope of Delivery | 14 |
| 1.4 Packaging and Labelling | 15 |
| 2. Installation and Setup | 16 |
| 2.1 Assembly and Preliminary Procedures | 16 |
| 2.2 General UV Treatment Rules | 18 |
| 2.2.1 Rules for Remote Operation of the UV Lamp | 19 |
| 2.2.2 Rules for Manual Operation of the UV Lamp | 19 |
| 2.2.3 Recommended Exposure Time | 19 |
| 2.3 Remote Control via Perenio Smart Mobile App | 20 |
| 2.4 Remote Control via Perenio Lite Mobile App..... | 26 |
| 2.5 Management via Voice Assistants | 30 |
| 2.6 Manual Control..... | 31 |
| 3 Maintenance and Repair | 32 |
| 4 Warranty Obligations..... | 33 |
| 5 Storage, Transportation and Disposal of Devices | 36 |
| 6 Other Information..... | 38 |
| 7 Troubleshooting..... | 39 |
| 8 Glossary | 40 |

Figures and Tables

| | |
|--|----|
| Figure 1 - Exterior | 11 |
| Figure 2 – Buttons, Ports and Indicators | 12 |
| Figure 3 – Scope of Supply | 14 |
| Figure 4 – Examples of installation..... | 16 |
| Figure 5 – Connection to the mains (With Power Link Wi-Fi) | 20 |
| Figure 6 – Connection to the mains (Without Power Link Wi-Fi)..... | 31 |
| Table 1 – Basic Technical Specifications of the UV Lamp..... | 13 |
| Table 2 – Recommended Exposure Time..... | 20 |
| Table 3 – Typical Errors and Troubleshooting Methods | 39 |

Connection to the Perenio Smart Mobile App

| | |
|---|----|
| A. INSTALLATION OF THE PERENIO SMART MOBILE APP | 21 |
| B. CONNECTION PROCESS (POWER LINK WI-FI)..... | 22 |
| C. SETTING THE TIMER | 23 |

Connection to the Perenio Lite Mobile App

| | |
|--|----|
| D. INSTALLATION OF THE PERENIO LITE MOBILE APP | 26 |
| E. CONNECTION PROCESS (POWER LINK WI-FI)..... | 27 |
| F. SETTING OF TIMERS | 28 |

1 General Description and Specifications

1.1 Device Purpose

Perenio® Smart Health UV Lamp is a low-pressure mercury lamp designed to destroy germs and dust mites with ultraviolet radiation and ozone at the site of installation. The lamp operates at short-wave ultraviolet light. The lamp operates within the range 260-275nm and destroys bacteria by burning out their DNAs and chromosomes. Ozone is also generated which oxidizes the air, thereby destroying bacteria and odor even in hard-to-reach areas*.

Key functional features of the UV Lamp are:

- Disinfection by ultraviolet and ozone;
- Treatment of large premises;
- Stable illumination and absence of noises due to ballast;
- Long service life of the UV tube;
- Remote control via mobile application, if connected to a Power Link device;
- Ease of use – no configuration required;
- Possibility of mounting on horizontal and vertical surfaces.

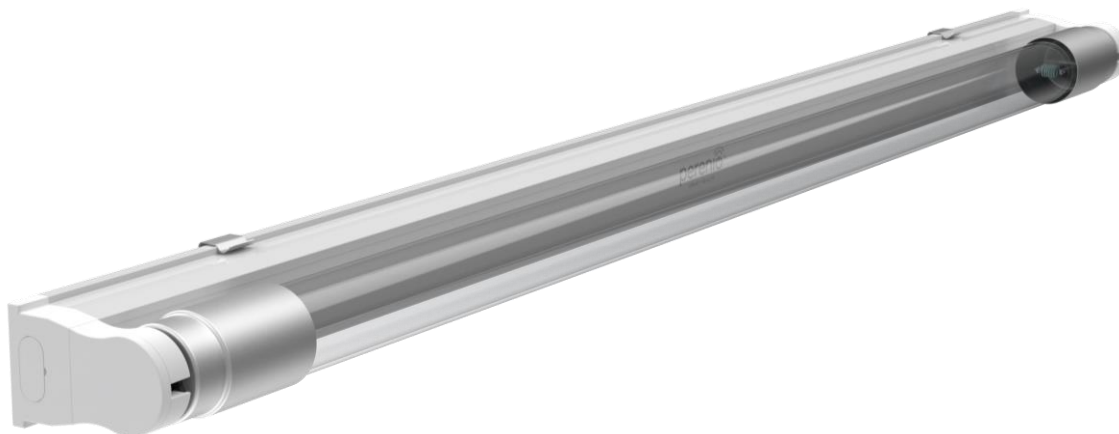

Figure 1 – Exterior

* Information is taken from open sources: [Effect of ozonation on pathogenic bacteria](#), [Effect of low-dose gaseous ozone on pathogenic bacteria](#), [Effects of ozone treatment on cell growth and ultrastructural changes in bacteria](#), [Ozone Antimicrobial Efficacy](#).

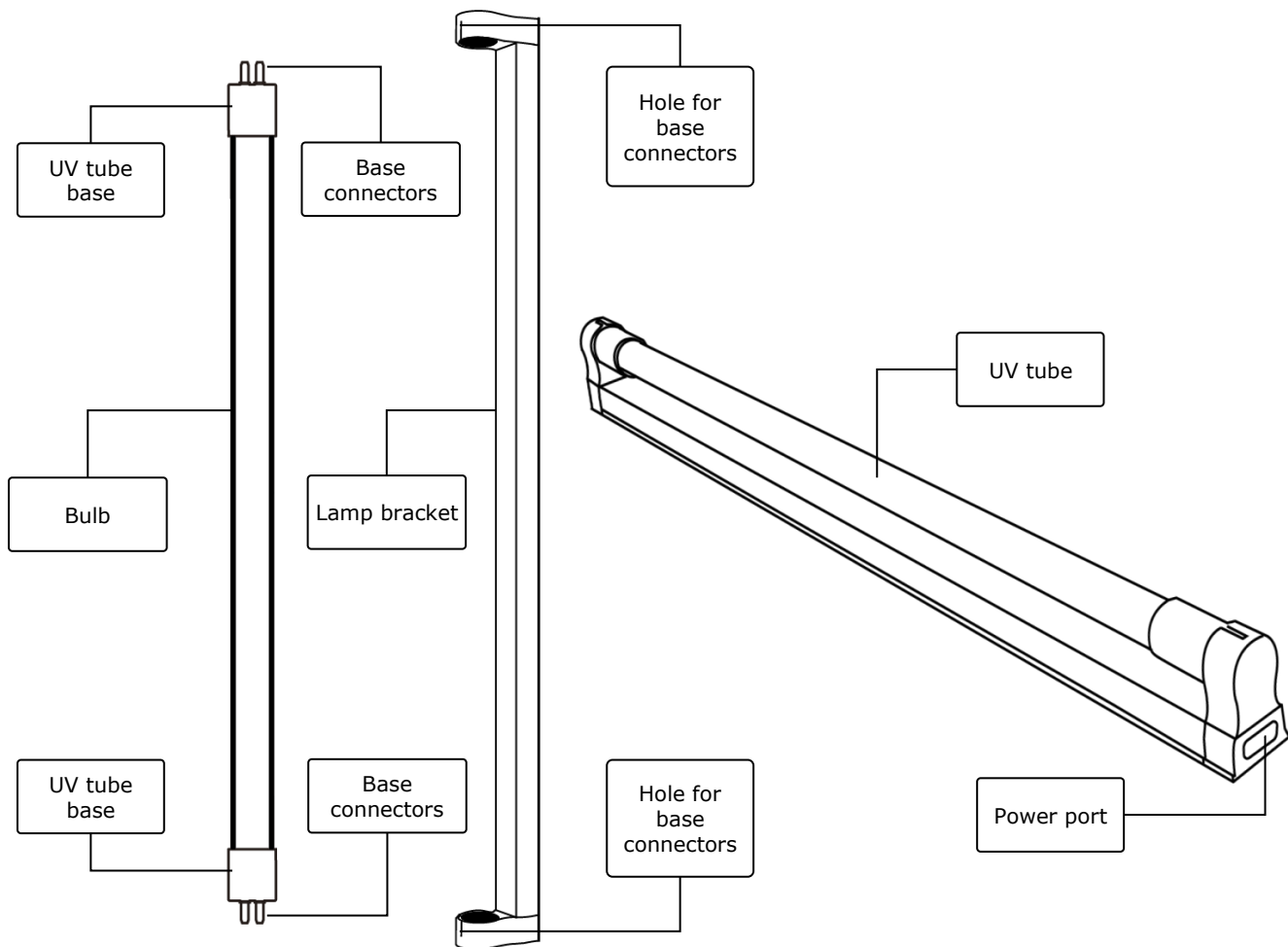

Figure 2 – Buttons, Ports and Indicators

Buttons, Ports and Indicators

| | |
|---------------------------------|---|
| UV tube base | UV lamp component used to insert the UV tube into the lamp bracket |
| Bulb | A cylindrical quartz glass tube with mercury content |
| Base connectors | Contacts used to insert the UV tube into the lamp bracket |
| Lamp bracket | Aluminum base of the UV lamp used for installation of the UV tube |
| Hole for base connectors | Slot in edges of the lamp bracket used to insert and remove the UV tube from the lamp bracket |
| UV tube | UV lamp component consisting of the bulb and the base |
| Power port | Port for connecting the UV lamp to the power source |

1.2 Technical Specification

Table 1 – Basic Technical Specifications of the UV Lamp

| Parameter | Value |
|-------------------------|--|
| Article | PELUV01 (white color) |
| Type | Low pressure mercury lamp |
| UV tube | Bulb type: T8 Base type: G13 |
| Type of radiation | UV-C |
| Radiation wavelengths | 260 nm to 275 nm |
| Radiation intensity | 78 $\mu\text{w}/\text{cm}^2$ |
| Mercury Content | 5 mg/kg max |
| Coverage Area | 3 m ² max Coverage angle: 240° |
| Power | Power: 20 W Voltage: 220-240 VAC (input), 40-100 V (output) Current: 100-250 mA Frequency: 50/60 Hz Limit switch type: Ballast |
| Operating Temperature | 0 °C to +40 °C |
| Operating Humidity | 10 % to 90 % RH (non-condensing) |
| Storage Temperature | -30 °C to +60 °C |
| Storage Humidity | 20 % to 90 % RH (non-condensing) |
| Casing Protection Class | IP20 |
| Installation | On a horizontal surface. On a vertical surface (mounting) |
| Casing Material | Lamp bracket: Aluminum UV Tube: Quartz glass |
| Color | White |
| Dimensions (L x W x H) | Lamp bracket: 610 x 30 x 50 mm UV Tube: Ø26 x 588 mm |

| Parameter | Value |
|------------------------|--------------------------------|
| Weight | 195 g (260 g with accessories) |
| Warranty Period | 2 years |
| Service Life (UV tube) | 6,000 hours |
| Certification | CE, EAC, RoHS |

1.3 Scope of Delivery

The following items and accessories are supplied within the **Perenio® PELUV01 UV Lamp** package:

1. PELUV01 UV Lamp (1 pc.)
2. Power cord (2m) (1 pc.)
3. Screws and dowels (1 set)
4. Mounting brackets (1 set)
5. Cover for unused power port (1 pc.)
6. Quick Start Guide (1 pc.)
7. Warranty Card (1 pc.)

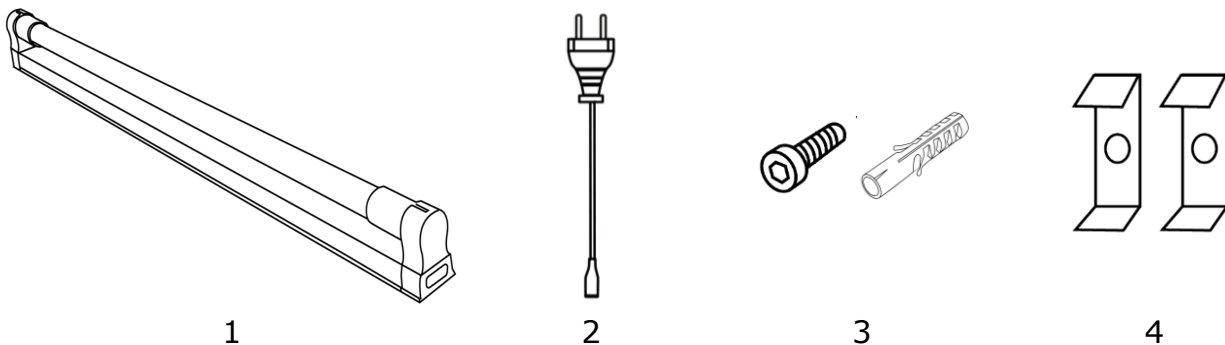

Figure 3 – Scope of Supply*

* Images of accessories are provided for informational purposes only

NOTE. The scope of delivery of PEKUV01 Lightsaber also includes the Power Link Wi-Fi device.

1.4 Packaging and Labelling

The **Perenio[®]** UV Lamp is supplied in a carton gift box of 655 x 86 x 55 mm (LxWxH) containing the full name and marking of the device, the list of accessories provided and basic technical specifications thereof, as well as the date of manufacture and information about the manufacturing plant of devices.

Weights of the package are as follows:

- Net weight: 195 g;
- Gross weight: 260 g.

2. Installation and Setup

Before installation, the User shall select one of the possible locations and mounting methods:

- On a vertical surface (wall, side surface of furniture, etc.);
- On a horizontal surface (table, cabinet, etc.).

Then, the User shall make sure that the selected location meets the following requirements:

- Availability of the power source at the installation area of the UV lamp;
- Lack of plants, paintings and fabric interior items;
- Ability to shut down air circulation in the room, i.e. tightly close windows and doors, turn off the supply and exhaust ventilation and block the air ducts.

Below see possible installation locations for the UV Lamp:

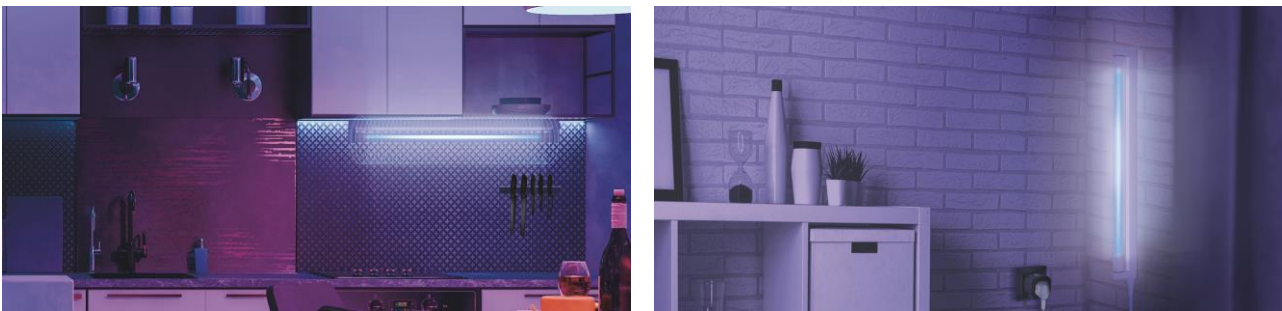

Figure 4 – Examples of installation*

* Images are provided for informational purposes only

2.1 Assembly and Preliminary Procedures

1. Unpack the UV Lamp and accessories.
2. Mount the brackets on a flat surface in the desired area using screws and dowels (The distance between the brackets shall not exceed 55 cm).



3. Remove the UV tube carefully from the lamp bracket as follows:

- Hold the base of the UV tube with the hand and rotate it in the lamp bracket until the connector is visible in the hole for base connectors;

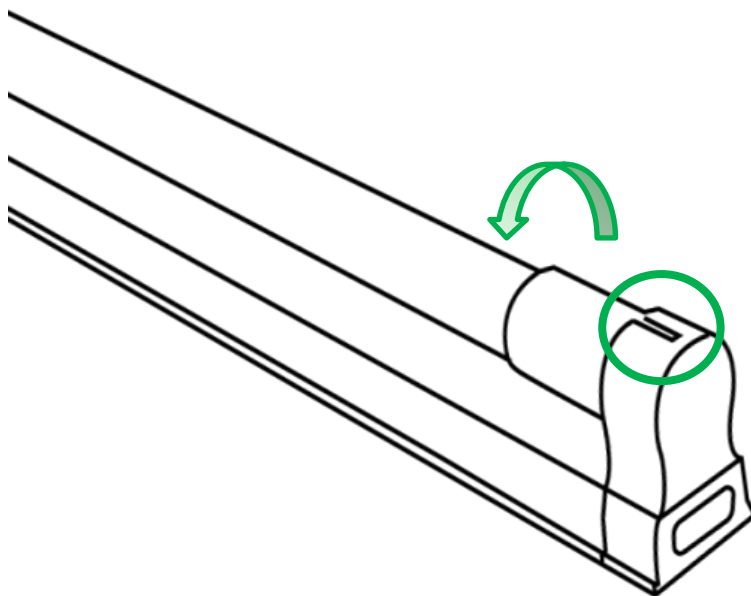

- Pull the UV tube base slightly in order to remove it from the lamp bracket.

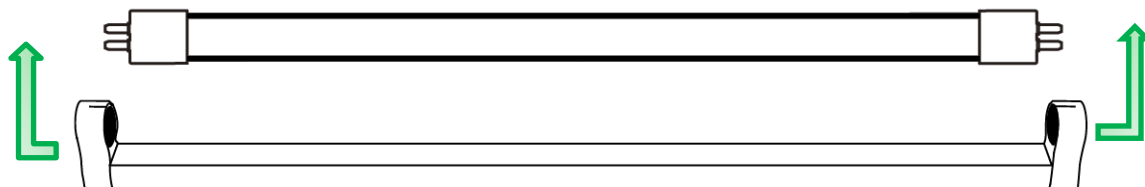

4. Insert the lamp bracket into the mounting brackets.

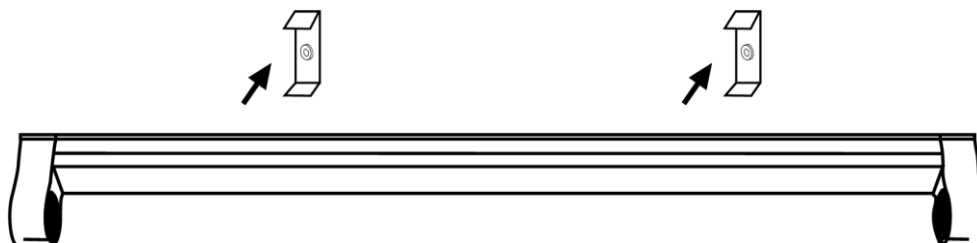

5. Carefully remove dirt, dust and fingerprints from the UV tube with a cotton cloth wet with alcohol.

ATTENTION! Failure to remove dust, dirt and fingerprints from the glass surface of the UV tube before operation may shorten its life.

6. Hold the bases with hands and insert the UV tube into the lamp bracket so that the base connectors are completely inserted into holes in the lamp bracket. Then, rotate the UV tube in the lamp bracket so that the connectors are not visible in the holes. **Do not touch the glass with your hands!**

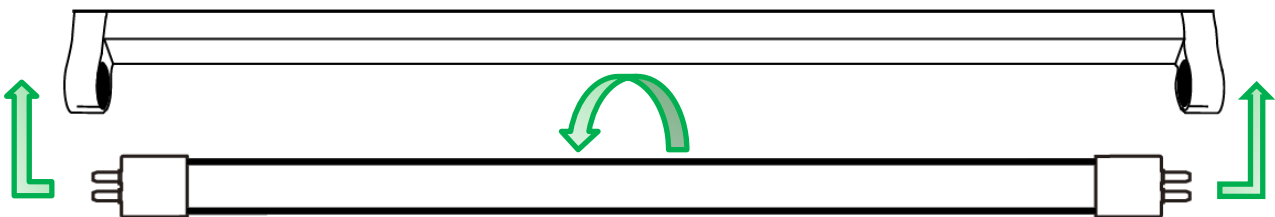

7. Connect the power cord to the UV lamp (**Do not connect the device to the power source**).
8. Close all windows tightly, turn off the air conditioner and/or block air ducts at the treatment site.
9. Select the way to control the UV lamp as follows:
 - Remote control via the **Perenio Smart/Perenio Lite** mobile app using the Power Link smart plug, or through voice assistants;
 - Manual control.

The UV lamp is deemed to be installed and ready for use.

2.2 General UV Treatment Rules

ATTENTION! Please read “Warnings and Restrictions” Section of this document carefully before turning on the device.

The most effective way is to use the UV lamp in rooms without air circulation at a temperature from +24 °C to +26 °C.

Please note that people, animals and plants are not allowed in the room during UV treatment, as well as immediately after the process is finished, since ultraviolet radiation and accumulated ozone may have a negative effect on their health and lead to respiratory damages.

2.2.1 Rules for Remote Operation of the UV Lamp

When managing the device via the **Perenio Smart/Perenio Lite** mobile application or via voice assistants, the following rules should be observed:

1. Before operation, close doors and windows in the room, as well as shut down the supply-and-exhaust ventilation and block the air ducts to ensure the proper level of disinfection.
2. Do not turn on the UV Lamp if any people and/or animals in the room.
3. Timely warn people about the time of UV treatment, or attach a disinfection schedule and a corresponding warning at the room entrance, as well as do not allow pets to enter the above premises.
4. Note that after the UV Lamp is turned off remotely, the room must be still thoroughly ventilated for at least 30 minutes before being used by people and/or animals.
5. Assign an appropriate name for the smart plug turning the UV lamp on and off in such a way as to easily distinguish it in the list of other smart plugs activated in the mobile application (for example, "UV lamp in the kitchen", "Smart plug for UV lamp").

2.2.2 Rules for Manual Operation of the UV Lamp

1. Turn the device on and off with dry hands only.
2. Before operation, close doors and windows in the room, as well as shut down the supply-and-exhaust ventilation and block the air ducts to ensure the proper level of disinfection.
3. Wear suitable eye and skin protection against UV radiation to turn the lamp on and off.
4. Do not inhale ozone vapors while next to the operating UV Lamp.
5. After turning off the UV lamp, ventilate the room for at least 30 minutes and keep people and/or animals out of it until the treated area is completely ventilated.

2.2.3 Recommended Exposure Time

The UV treatment period depends on the room type and the area of installation of the device. See the approximate UV expose time for the **PELUV01** UV Lamp in the table below.

Table 2 – Recommended Exposure Time

| Area of Exposure | Recommended Exposure Time |
|-----------------------|---------------------------|
| 10 m ² max | 15 minutes |
| 20 m ² max | 30 minutes |
| 30 m ² max | 45 minutes |

2.3 Remote Control via Perenio Smart Mobile App

ATTENTION! The Power Link (PEHPL01-PEHPL04) or the Power Link Wi-Fi (PEHPL10) device shall be used to control the UV lamp via the Perenio Smart mobile application.

Below see the way to connect the UV Lamp to the mains, if remotely controlled.

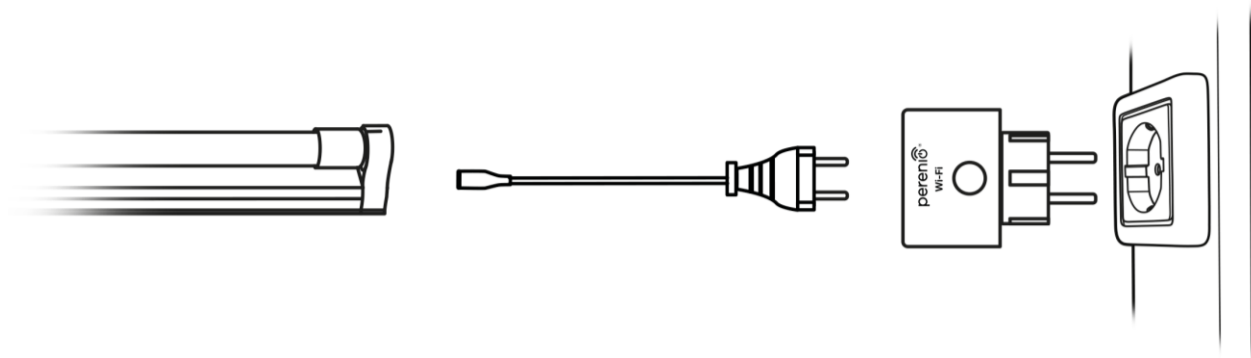

Figure 5 – Connection to the mains (With Power Link Wi-Fi)

NOTE. The Power Link (PEHPL01-PEHPL04) device is activated in the mobile app via the **Perenio®** IoT Router or the Control Gateway, while the Power Link Wi-Fi (PEHPL10) device is activated directly to the app.

1. Install the **Perenio Smart** mobile application and activate the Power Link or Power Link Wi-Fi device (See pars. **A** and **B** below).
2. Turn off the smart plug and make sure that it is in the **OFF** state in the mobile application.
3. Connect the UV lamp to the smart plug using the power cord (See Figure 5 above).
4. Prepare the room for UV treatment and leave it.

5. Use the Power Link device functionality to remotely turn on and off the UV lamp via the mobile application using timers, scenarios (Currently, for PEHPL01-PEHPL04 only) and power on/off function (See par. **C** below).

A. INSTALLATION OF THE PERENIO SMART MOBILE APP

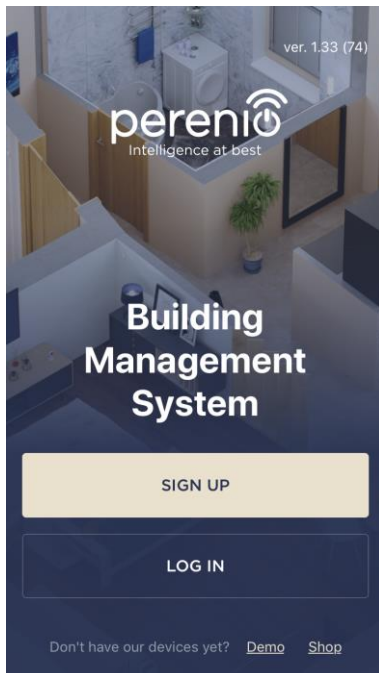

The device shall be managed via a free mobile application available for downloading in Google Play or App Store. In order to log in to the User Account, follow the steps below:

- a. Connect your smartphone to the Wi-Fi Network and download the **Perenio Smart Home & Office** app from Google Play or App Store;
- b. Register a new User Account or sign in to an existing User Account as follows:
 - **Registration:**
 - Fill in your e-mail address, user name and password (8 or more symbols including at least one capital letter and one number);
 - select the country of residence;
 - Agree to General Terms of Privacy Policy;
 - Click on the **SIGN UP** button.
 - The User will receive an email to verify the User Account (Follow the link);
 - Log in to the User Account.

- **Logging in to the existing account:**
 - Enter your e-mail address and password in the login screen;
 - Click on the **LOG IN** button.

NOTE. If the password is lost, the User can restore it by clicking on a corresponding link on the screen.

To restore a forgotten password, use the e-mail address linked to your User Account, as instructions on changing the password will be sent thereto.

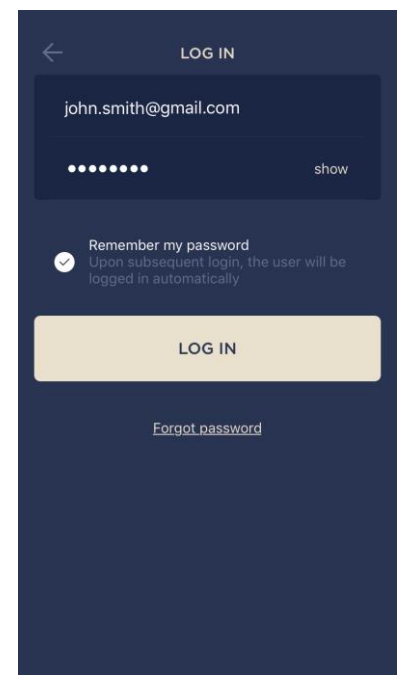

B. CONNECTION PROCESS (POWER LINK WI-FI)

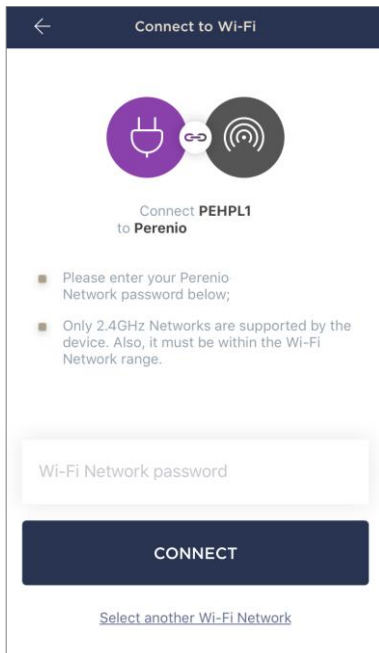

- a. After login to the User Account, click on the “+” icon in the right upper corner of the “Devices” tab and select the smart plug in the list;
- b. Select the device type – Power Link (Wi-Fi);
- c. Enter the password from the Wi-Fi Network or select another network;

NOTE. The device may be connected to Wi-Fi Network of **2.4GHz** only.

- d. Click on the **CONNECT** button;

NOTE. Before connecting, make sure that the smart plug is powered on and that the smartphone is located at a distance of not more than 2 meters from it.

- e. Press and hold the power button until the LED indicator starts blinking;
- f. Click on **START SEARCHING** button;
- g. Wait for the connection process to be completed.

NOTE. If any failures, follow instructions specified on corresponding screens of the smartphone.

After successful connection of the device, the User may specify the following:

- a. Image;
- b. Device name;
- c. Device Location;
- d. Room.

After completion, click on the **DONE** button.

NOTE that all the above data may be entered or edited on a later basis in the device control panel.

The smart plug will be displayed in the “Devices” tab.

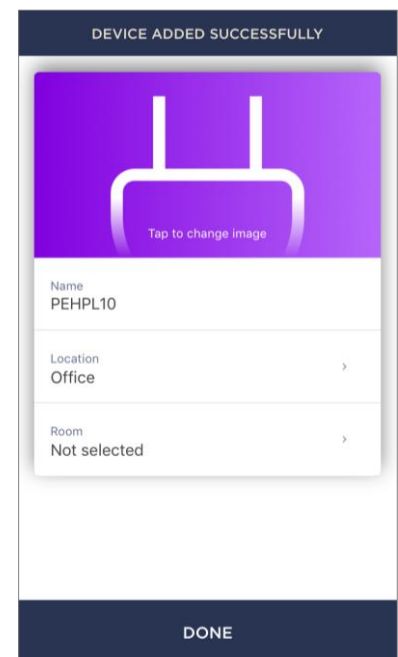

C. SETTING THE TIMER

Scheduled timers are used to automatically turn on and/or off the smart plug at a specified time on specified days of the week.

By default, no scheduled timers are available as presets for the device.

NOTE that available options to set timers depend on the selected action for the smart plug (turning on or off).

Setting the scheduled timer to turn on the Power Link Wi-Fi

1. Click on the "Scheduled Timer" button in the device control panel. Then, click on the "+" icon in the right upper corner of the screen.
2. In the "Add scheduled event" screen, select the power type – "Turn on".

POWER:

Turn on

Turn off

3. Select the turn-on time for the power plug.

🕒 Turn-on time
10:44 AM

| | | |
|-----------|-----------|-----------|
| > | < | |
| 8 | 41 | |
| 9 | 42 | |
| 10 | 44 | AM |
| 11 | 45 | PM |
| 12 | 46 | |
| 1 | 47 | |

4. Select the turn-off time, if required.

Enable Turn-off time

Power link will turn power off at selected time

Turn-off time
11:44 AM

NOTE that the turn-off time activation is optional.

5. Select days of the week when the power plug shall operate according to the timer.

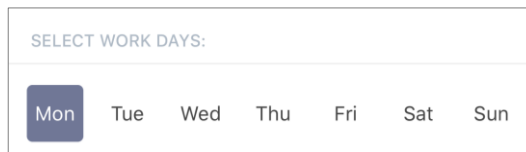

- 6. Click on the "Save" button.
- 7. Activate the timer in the list.

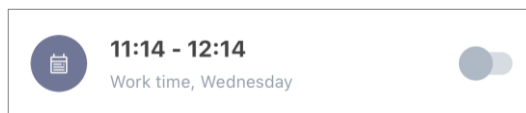

8. The User may make changes to the created timer by clicking on it in the list of timers.

NOTE. If the User shall try to change settings of an activated timer, it will be automatically disabled.

A maximum of fifteen (15) weekly timers can be activated at a time.

Setting the scheduled timer to turn off the Power Link Wi-Fi

- 1. Click on the "Scheduled Timer" button in the device control panel. Then, click on the "+" icon in the right upper corner of the screen.
- 2. In the "Add scheduled event" screen, select the power type – "Turn off".

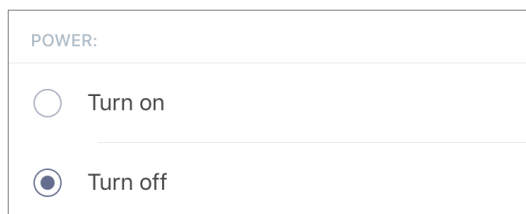

3. Select the turn-off time for the power plug.

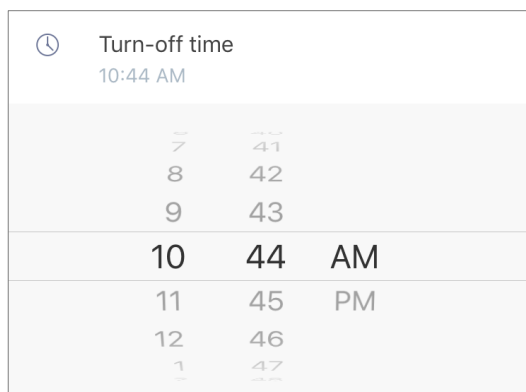

4. Select the turn-on time, if required.

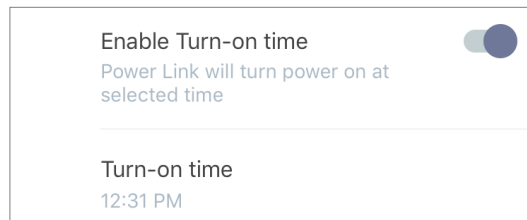

NOTE that the turn-on time activation is optional.

5. Select days of the week when the power plug shall operate according to the timer.

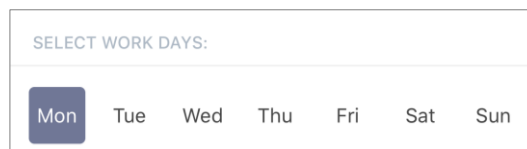

- 6. Click on the "Save" button.
- 7. Activate the timer in the list.

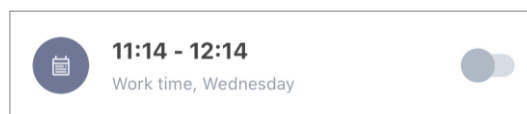

8. The User may make changes to the created timer by clicking on it in the list of timers.

NOTE. If the User shall try to change settings of an activated timer, it will be automatically disabled.

A maximum of fifteen (15) weekly timers can be activated at a time.

Deleting the weekly timer

To delete a timer, the User shall slide a finger over it from left to right in the "Scheduled timer" tab and click on the trash icon.

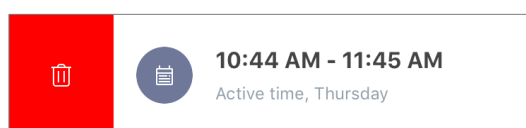

NOTE that the User may only delete a disabled timer.

For details on the functionality of smart plugs, see corresponding manuals downloadable from **perenio.com**.

2.4 Remote Control via Perenio Lite Mobile App

ATTENTION! The Power Link Wi-Fi (PEHPL10) device shall be used to control the UV lamp via the Perenio Lite mobile application.

1. Install the **Perenio Lite** mobile application and activate the Power Link Wi-Fi device (See pars. **D** and **E** below).
2. Turn off the smart plug and make sure that it is in the **OFF** state in the mobile application.
3. Connect the UV lamp to the smart plug using the power cord (See Figure 5 above).
4. Prepare the room for UV treatment and leave it.
5. Use the Power Link Wi-Fi device functionality to remotely turn on and off the UV lamp via the mobile application using timers and power on/off function (See par. **F** below).

D. INSTALLATION OF THE PERENIO LITE MOBILE APP

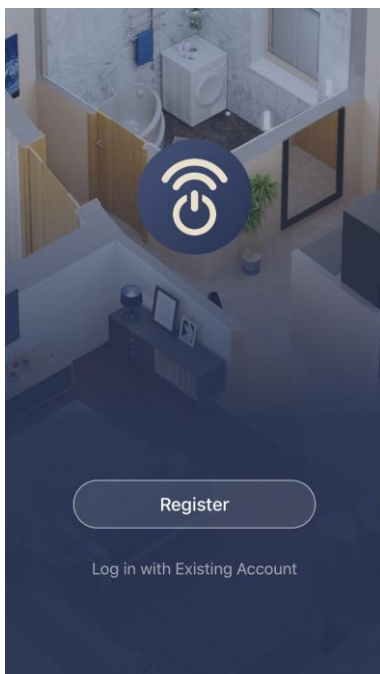

The device shall be managed via a free mobile application available for downloading in Google Play or App Store.

In order to log in to the User Account, follow the steps below:

- a. Connect your smartphone to the Wi-Fi Network and download the **Perenio Lite** app from Google Play or App Store;
- c. Register a new User Account or sign in to an existing User Account as follows:
 - **Registration:**
 - Agree to General Terms and Privacy Policy;
 - Select the country of residence;
 - Fill in your e-mail address and click on "Get Verification Code";
 - Enter the code received at the specified email box;
 - Set the password (6 to 20 symbols including at least one capital letter and one number);
 - Log in to the User Account.

- **Logging in to the existing account:**
 - Enter your e-mail address and password in the login screen;
 - Click on the **LOG IN** button.

NOTE. If the password is lost, the User can restore it by clicking on a corresponding link on the screen.

To restore a forgotten password, use the e-mail address linked to your User Account, as instructions on changing the password will be sent thereto.

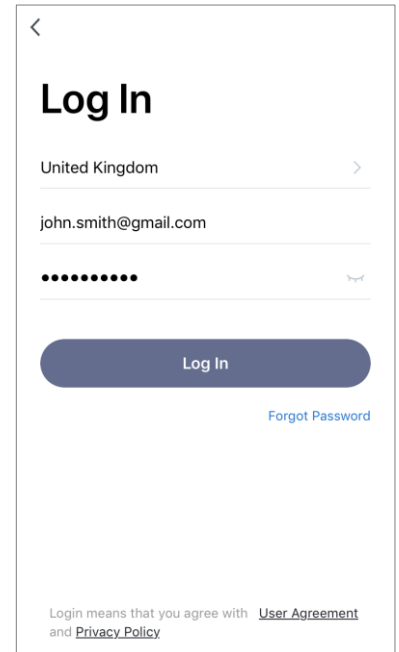

E. CONNECTION PROCESS (POWER LINK WI-FI)

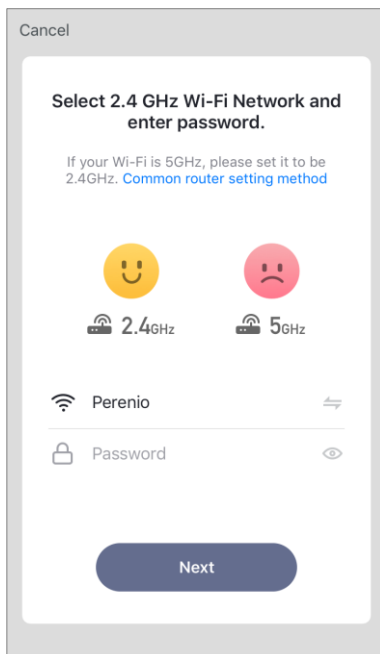

- a. Click on the "+" icon in the "Home" tab;
- b. Select "Socket (Wi-Fi)" in the "Electrician" Section;
- c. Enter the password from the Wi-Fi Network or select another network;

NOTE. The device may be connected to Wi-Fi Network of **2.4GHz** only.

- d. Click on the **CONNECT** button;

NOTE. Before connecting, make sure that the smart plug is powered on and that the smartphone is located at a distance of not more than 2 meters from it.

- e. Press and hold the power button until the LED indicator starts blinking, and press the "Next" button;
- f. Confirm that the indicator is rapidly blinking by ticking the box, and press the "Next" button;
- g. Wait for the connection process to be completed.

NOTE. If any failures, follow instructions specified on corresponding screens of the smartphone.

After successful connection of the device, the User may specify the following:

- a. Image;
- b. Device name;
- c. Device Location.

To do this, click on the image of the smart plug in the "Home" tab, then click on the "edit" icon in the right upper corner of the device control panel. The smart plug setting screen will be displayed. After that, click on the "edit" icon in the right upper corner of the screen once again.

The smart plug will be displayed in the "Home" tab.

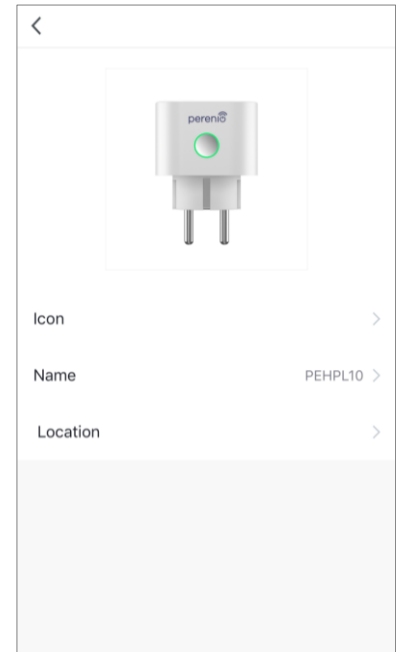

F. SETTING OF TIMERS

There are 2 kinds of timers in the control panel, namely:

- Weekly timer; and
- Countdown timer.

The weekly timer is used to automatically turn on and/or off the smart plug at a specified time on specified days of the week.

The countdown timer allows the User to turn on or off the device automatically after the specified time interval.

Setting the scheduled timer to turn on/off the Power Link Wi-Fi

To set the timer, the User shall go to the "Weekly timer" tab by clicking on the corresponding icon at the bottom of the control panel.

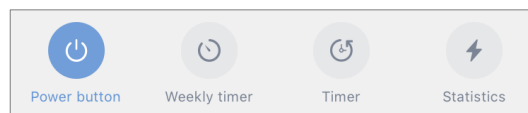

1. Click on the "Add Schedule" button in "Weekly timer" tab.
2. Select time to turn on or off the power plug.

| | |
|-----------|-----------|
| 12 | 38 |
| 13 | 39 |
| 14 | 40 |
| 15 | 41 |
| 16 | 42 |
| 17 | 43 |
| 18 | 44 |

- Click on the "Repeat" button to select days of the week when the smart plug shall operate according to the timer.

Repeat
Once >

- Enable push notifications for the timer, if required.

Notification

NOTE that push notification activation is optional.

- Select the action to be performed by the timer (turning the device on or off).

Power button
ON >

- Click on the "Save" button.
- Activate the timer in the list.

<
Schedule

Time variance is ±30s

12:03 PM

Once
Power button:ON

- The User may make changes to the created timer by clicking on it in the list of timers.

NOTE. To delete a timer, the User shall slide a finger over it from right to left in the "Weekly timer" tab and click on the trash icon.

12:03 PM

Power button:ON

Delete

Setting the countdown timer

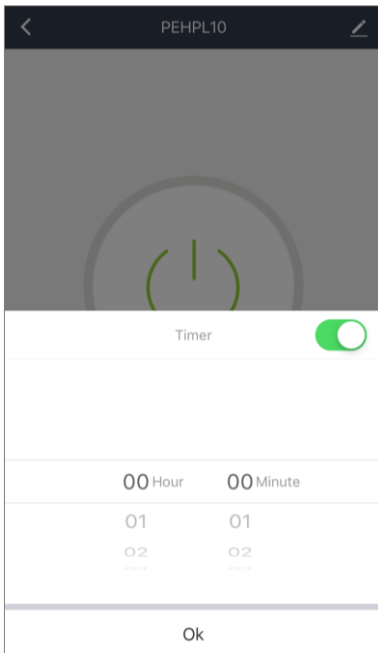

The countdown timer can be set by clicking on the “Timer” icon at the bottom of the smart plug control panel (See Figure on the left).

NOTE that if the smart plug is turned on and the countdown timer is activated, the device will be turned off after the specified time interval, and vice versa.

The timer is considered activated if the toggle switch is set to the appropriate state.

To save the timer settings, click on the “OK” button.

The device on/off time will be displayed in the control panel.

For details on the functionality of smart plugs, see corresponding manuals downloadable from **perenio.com**.

2.5 Management via Voice Assistants

To control the smart plug via the Google Home, Amazon Alexa, Apple Siri, it must be first activated in the **Perenio Smart** or **Perenio Lite** application.

NOTE that when activating the Power Link Wi-Fi in Google Home, Apple Siri and/or Amazon Alexa, the User shall follow instructions specified in corresponding Google applications or uploaded at **perenio.com/faq**.

2.6 Manual Control

Below see the way to connect the UV Lamp to the mains, if manually controlled.

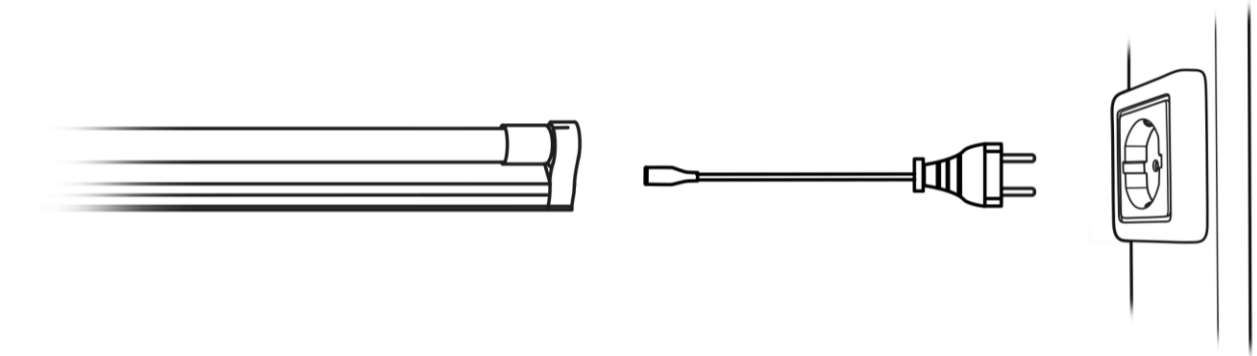

Figure 6 – Connection to the mains (Without Power Link Wi-Fi)

ATTENTION! In the case of manual control, the User must comply with the rules for staying in UV treated room, i.e. wear special eye and skin protection.

The manual control of the UV lamp shall be as follows:

1. To turn on the UV lamp, the User shall connect it to the mains with a cable.
2. To turn off the UV lamp, the User shall disconnect it from the mains.

3 Maintenance and Repair

The **Perenio® Smart Health** UV Lamp does not require special maintenance in the normal course of operation. However, in order to maintain the proper state and stable operation of the device the User shall follow the safety operation rules, warnings, and precautions (See the “Warnings and Restrictions” Section).

The **Perenio® Smart Health** UV Lamp repairs shall be carried out in Service Centers. The UV Tube cannot be repaired due to mercury content.

In the case of warranty repairs or replacement, the User shall provide the Seller with the sales receipt and the purchased device.

For details on the replacement and repairs of the **Perenio® Smart Health** UV Lamp, please contact your local Company representative or the Tech Support Department at **perenio.com**.

NOTE. The expected useful life of the UV tube is 6,000 operating hours. After this period, certain changes occur, so quartz cannot emit short-wave ultraviolet radiation, and the disinfecting effect ceases.

4 Warranty Obligations

The warranty period for the **Perenio[®] Smart Health** UV Lamp shall be **Twenty-Four (24) months** from the date of sale to the End User.

The warranty period for the cable is **Six (6) months** from the date of sale to the End User.

ATTENTION! The UV tube is not covered by the warranty as they are subject to natural wear and tear and must be replaced from time to time at a Service Center.

The Manufacturer claims a device service life of **6,000 hours** for the UV tube.

The Warranty Card shall be deemed valid provided that it is correctly and completely filled in by the Seller. Upon the purchase, the Customer shall check that both the Serial Number and the Model name of the device corresponds to those indicated in the Warranty Card.

Incomplete or illegible Warranty Card shall be deemed not valid. In this case, it is recommended to contact the Seller and ask for a duly filled Warranty Card. It shall be also allowed to provide the original of the sales/cashier's receipt or such other documentary evidence of the fact and the date of sale of the device. The date of sale shall be the date indicated on the sales/cashier's receipt or other relevant document. If the date of sale is not possible to be determined, the start of the warranty period shall be the date of manufacture of the device.

The Manufacturer shall guarantee that all materials, components and assemblies of **Perenio[®]** devices are free from defects under normal operation within the warranty period. The limited warranty shall be applied to the first End Customer of **Perenio[®]** devices only and cannot be transferred to a subsequent customer.

For warranty replacement, the device must be returned to the Seller along with its receipt. Warranty obligations for **Perenio[®]** devices shall be provided in the country of their purchase only.

WARRANTY SERVICE PROCEDURE

In the case of any alleged defect or deficiency of the device detected, the Customer shall contact the Authorized Service Center before the warranty period expiration and provide the following:

1. The device with an alleged defect or deficiency.

2. The Warranty Card filled out in accordance with the applicable legal requirements, or the original of the document confirming the purchase of the device, including clear indication of the name and the address of the Seller, as well as the date when this device was sold.

LIMITATION OF LIABILITY

Perenio® devices SHALL NOT BE SUBJECT TO a free warranty service in the case of identification of at least one of the following damages or defects:

- Any damage caused by force majeure, accidents, and willful or careless acts (omissions) of the Customer or third parties;
- Any damage caused by the impact of other objects including but not limited to exposure to moisture, dampness, extreme temperatures or environmental conditions (or jumps in such conditions), corrosion and oxidation, as well as penetration of flood and liquid, and the effects of chemicals, animals, insects and byproducts thereof;
- In the event when the device (accessories and/or components) was unsealed (the seal integrity was violated), modified or repaired by any party other than the Authorized Service Center, including repair works using unauthorized spare parts;
- Any defects or damage caused by improper or unintended use of the device, including operation contrary to available manuals;
- Any defects caused by natural wear and tear of Products, including bags, casings, batteries or Installation and Operation Manuals;
- In the event when the Serial Number (Name Plates), the date of manufacture or the Model name on the device casing was in any way removed, erased, affected, altered or made illegible;
- In the case of violation of operating procedures and conditions, as well as the device installation instructions described in relevant Manuals;
- Cracks, scratches and other defects caused as a result of transportation and/or operation of the device by the Customer or acts of negligence on their part;
- Mechanical damages that occurred after transferal of the device to the Customer including damage caused by sharp objects, bending, squeezing, falling, etc.;
- Any damage caused by non-conformity with the standards of power supply, telecommunication and cable networks or similar external factors.

THE PRESENT LIMITED WARRANTY IS AN EXCLUSIVE AND THE ONLY PROVIDED GUARANTEE THAT SHALL REPLACE ANY OTHER EXPRESS AND IMPLIED GUARANTEES. THE MANUFACTURER SHALL PROVIDE NO GUARANTEES, WHETHER EXPRESS OR IMPLIED, BEYOND THE DESCRIPTION CONTAINED IN THE PRESENT DOCUMENT, INCLUDING THE IMPLIED WARRANTY OF MERCHANTABILITY AND

FITNESS FOR A PARTICULAR PURPOSE. THE CUSTOMER MAY USE DEFECTIVE OR INAPPLICABLE DEVICE AT HIS/HER OWN DISCRETION. THE MANUFACTURER SHALL NOT BE RESPONSIBLE FOR DAMAGE TO OTHER PROPERTY CAUSED BY DEVICE DEFECTS, THE LOSS OF USABILITY OR TIME OR FOR ANY SPECIAL, INCIDENTAL, INDIRECT OR CONSEQUENTIAL DAMAGE OR LOSS INCLUDING BUT NOT LIMITED TO COMMERCIAL LOSS, LOSS OF PROFITS, LOSS OF CONFIDENTIAL OR OTHER INFORMATION, AS WELL AS DAMAGES CAUSED BY BREAKS IN COMMERCIAL OR PRODUCTION ACTIVITIES DUE TO THE FACT THAT THE DEVICE WAS RECOGNIZED AS FAULTY, DEFECTIVE OR NOT ALLOWED FOR USAGE.

The present limited warranty shall provide the Customer with certain legal rights. The Customer may also have other rights in accordance with the local consumer protection laws that vary from country to country and may not coincide with this limited warranty. For full understanding of the Customer's rights, you shall read local acts.

NOTE. The Manufacturer does not produce equipment for *Vital Tasks*. Vital Task Products shall include life support systems, medical equipment, implantation-related medical devices, commercial transportation, nuclear equipment or systems, and any other fields of application where equipment failures may do harm to a humans' health or cause their deaths, as well as result in a property damage.

5 Storage, Transportation and Disposal of Devices

The **Perenio®** UV Lamp may be shipped by any kind of covered vehicles (by rail, or road or in sealed heated airplane compartments, etc.) in accordance with the requirements of current regulatory documents applicable to fragile goods sensitive to moisture.

Similar conditions shall apply to the device storage at the Seller's warehouse.

In accordance with the Waste Electrical and Electronic Equipment (WEEE)* regulations, all electrical and electronic products must be collected separately at the end of their service life, and cannot be disposed of together with unsorted household waste.

Parts of worn out devices must be separated and sorted by the material type. In this way, every user can contribute to reuse, recycling and other forms of recovery of waste electrical and electronic equipment. Proper collection, recycling, and disposal of such devices will help avoid potential environmental and health impacts from the harmful substances they contain.

To dispose of the device, it must be returned to the point of sale, or to a local waste collection and recycling company recommended by the state or local authorities. Disposal is carried out in accordance with the applicable laws and regulations of the respective country.

For more details on how to properly dispose of your used device, please contact your device supplier, your waste disposal service or the local authorities responsible for waste disposal.

NOTE. The User must comply with the temperature and humidity conditions of storage and transportation specified in the Table of technical specifications of the present Installation and Operation Manual.

* Waste Electrical and Electronic Equipment, or WEEE, means used electrical or electronic equipment, including all components, assemblies, consumables that are part of the equipment at the time it is taken out of service (including supplied batteries (if any), components containing mercury, etc.).

To dispose of a device that contains mercury, the User must take it to their local recycling facility due to the following reasons:

- If the UV tube is damaged, mercury vapors will be released into the air, water and/or soil and contaminate it, as well as may bring harm to human health, if the vapors are inhaled;
- The UV lamp components may also need to be recycled.

If the User cannot dispose of the device in a specialized facility for recycling of lamps, then they can also take it to a hardware and household store, the local department of the Ministry of Emergencies or a similar institution.

For the device disposal purposes, it shall be returned to the point of sale or to the local processing center.

For detailed information on recycling of the present device, please contact your waste management company.

6 Other Information

Manufacturer

| | |
|--------------|--|
| Name | <i>Perenio IoT spol s r.o.</i> |
| Address | Na Dlouhem 79, Ricany – Jazlovice 251 01, Czech Republic |
| Contact Info | perenio.com, info@perenio.com |

Importing Company

| | |
|--------------|--|
| Name | <i>ASBISc Enterprises PLC</i> |
| Address | Iapetou, 1, Agios Athanasios, 4101, Limassol, Cyprus |
| Contact Info | Tel.: +357-25-85-70-00, e-mail: info@asbis.com |

Info on Certificates and Declarations

| | |
|--------------|---|
| Certificates | Certificate of Compliance CE BSTXD200414778601SC as of April 7, 2020 Certificate of Compliance RoHS BST200414778601CC as of August 9, 2020 |
| Declarations | EC Declaration of Conformity as of July 31, 2020 RoHS Compliance Declaration as of July 31, 2020 |

Addresses of Service Centers are available at **perenio.com** in the "Support" Section.

7 Troubleshooting

Table below shows typical errors and problems that may occur in the process of using the UV Lamp.

Table 3 – Typical Errors and Troubleshooting Methods

| Item No | Problem | Possible Reasons | Solution |
|---------|--------------------------|--|------------------------|
| 1 | UV Lamp does not turn on | The UV tube does not fit tightly to the lamp bracket | Reassemble the UV lamp |
| 2 | UV tube is not working | UV tube is damaged | Replace the UV tube |
| | | Service life of the UV tube has ended | Replace the UV tube |

8 Glossary

| | |
|-------------|---|
| UV-C | Electromagnetic spectrum of ultraviolet light, determined by the short-wave range with a wavelength of 280-100 nm |
| IP20 | The degree of protection of the device, indicating that parts inside the case are protected from the penetration of fingers or objects longer than 80 mm and solid bodies larger than 12 mm. No moisture protection |